

iCompact

Lifts

This model has the same technology as the Ecomagnet range but is designed to optimize the lift shaft to offer more space in the car. It is designed to be installed in apartment buildings or neighbouring communities.

Like the Ecomagnet models, they do not need a machine room to work.

This lift is designed for communities, work centres, public buildings and homes.

 225 - 675 kg

 3 - 9 persons

 Maximum travel 45 m

 At 180°, 90° and 0°

 Electric

 Speed 1 m/s

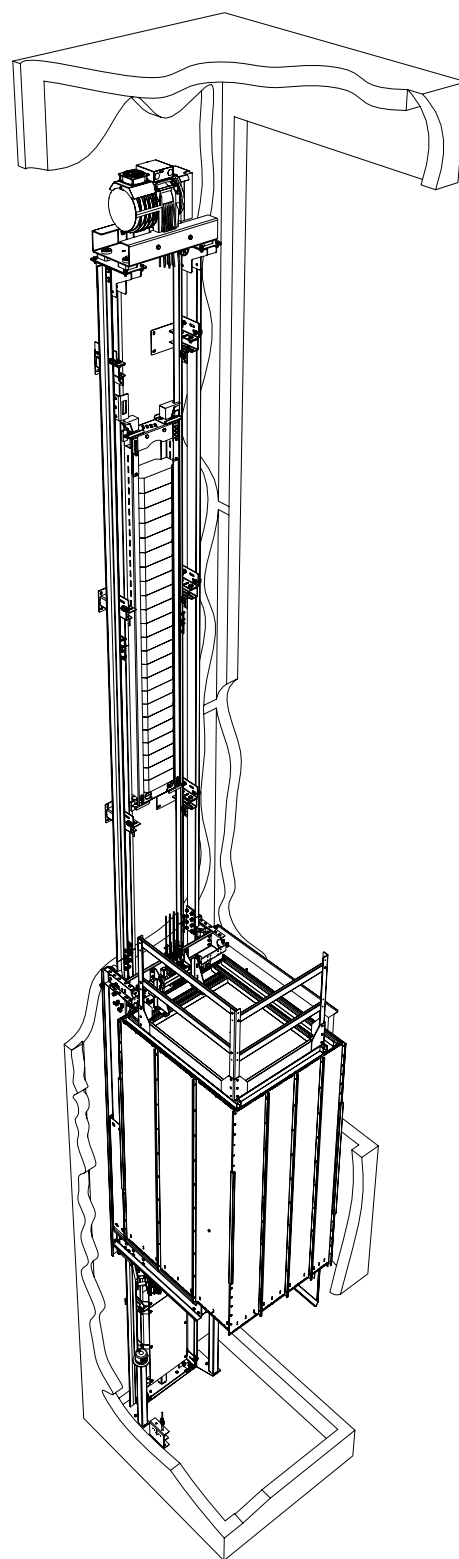

iC_1L

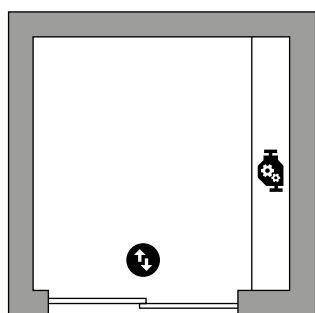

iC_1F

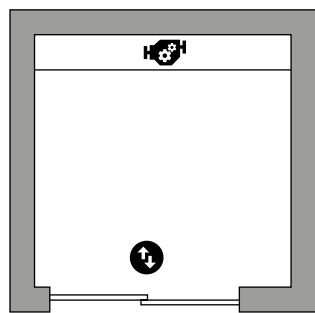

iC_2-180

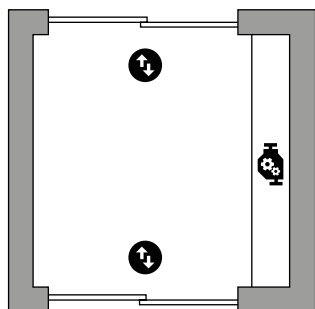

iC_2-90

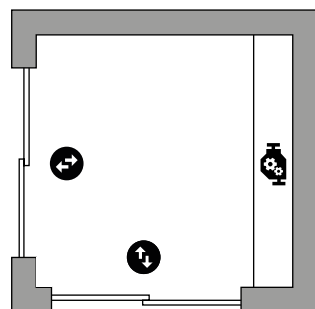



Basic configuration

- Car doors in epoxy.
- Car door in stainless steel.
- Skinplate car. Z1 car
- Selective simplex on descent.
- Manual rescue control.
- Stainless steel car keypad with round buttons and with BRAILLE.
- Landing keypad in the steel door frame stainless with oval or round button and with BRAILLE.
- Digital position, directional arrows and load weighing in the car.
- Intercom.
- Acoustic indicator of doors opening.
- Voice synthesizer.
- Optical curtain. (Safety edge)

iC_1L

Layouts and drawing



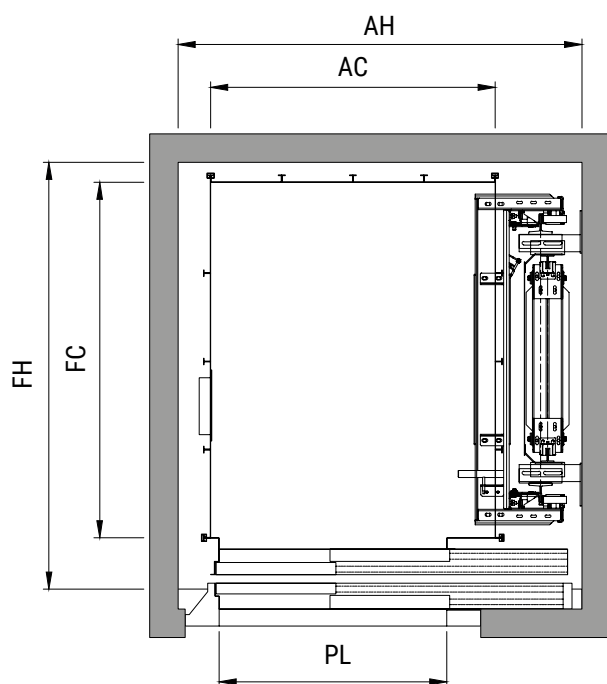



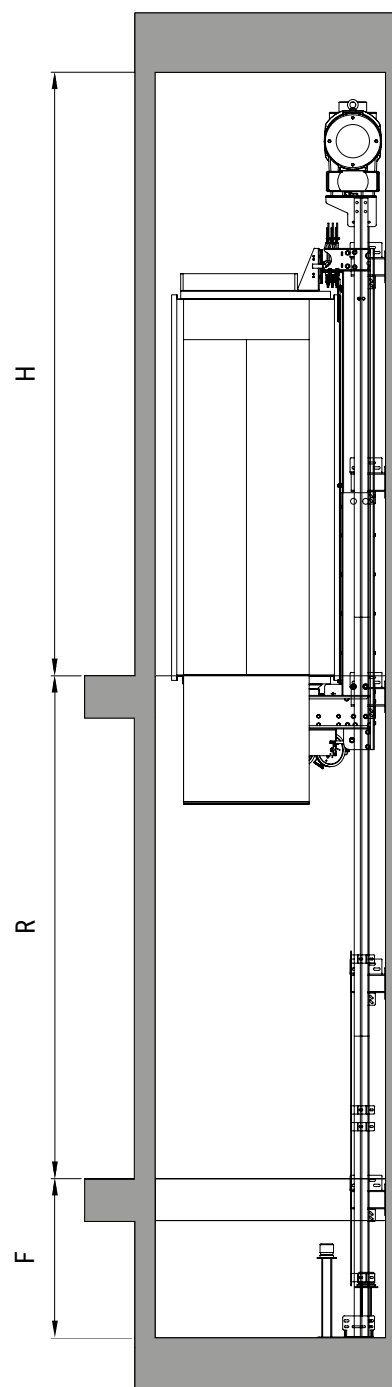







Plan view



Height



PL	Door opening
AC	Car width
FC	Car depth
AH	Pit width
FH	Pit depth
R	Travel
H	Headroom
F	Pit

REFERENCE	Characteristics				Doors			Car			Pit			
	Q Kg	P	V m/s	PT kW	T	PL mm	AP mm	AC mm	FC mm	A mm	AH mm	FH mm	F mm	H mm
														
iC31L	225	3	1	1,62	2T	650	2000	800	900	2220	1230	1150	1450	3600
	225	3	1	1,62	SB	700	2000	800	900	2220	1240	1100	1450	3600
iC41L	320	4	1	2,22	2T	700	2000	900	1000	2220	1330	1260	1180	3600
	320	4	1	2,22	SB	700	2000	900	1000	2220	1330	1210	1180	3600
iC51L	375	5	1	2,59	2T	700	2000	1000	1100	2220	1430	1350	1005	3600
iC61L	450	6	1	3,07	2T	800	2000	1000	1250	2220	1430	1500	1005	3600
iC71L	525	7	1	3,45	2T	800	2000	1100	1250	2220	1570	1500	1005	3600
iC81L	630	8	1	4,11	2T	900	2000	1100	1400	2220	1570	1650	1005	3600
iC91L	675	9	1	4,37	2T	900	2000	1200	1400	2220	1670	1650	1005	3600
	PT Power Q Loading capacity P Max. n° of people V Speed				PL Doors opening AP Height of doors 2C 2 Panel side openings 2T 2 P. central openings SB Semi-automatic + bus T Type of door			AC Car width FC Car depth A Height			AH Pit width FH Pit depth F Pit H Headroom			

- Dimensions for standard cars and skinplate decoration with porcelain floor.

- If the dimensions of your lift and car do not correspond to that of the standard measurements consult our sales team.

- 1 entrance car.

iC_1F

Layouts and drawing



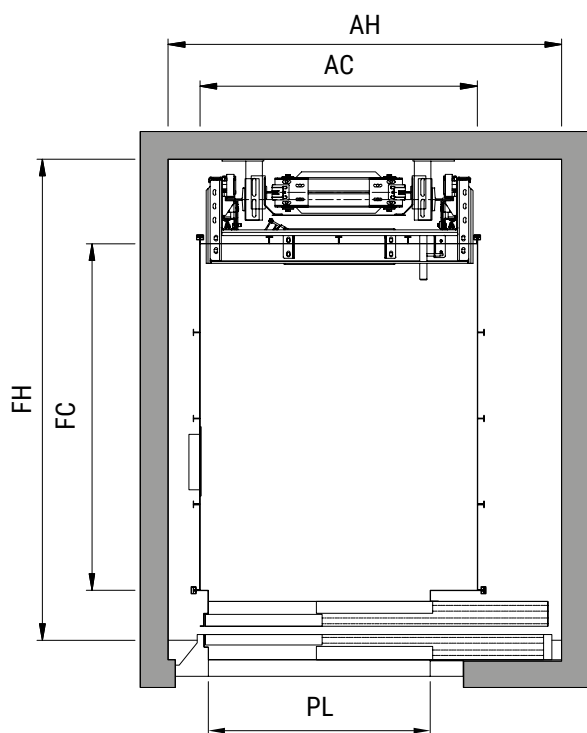



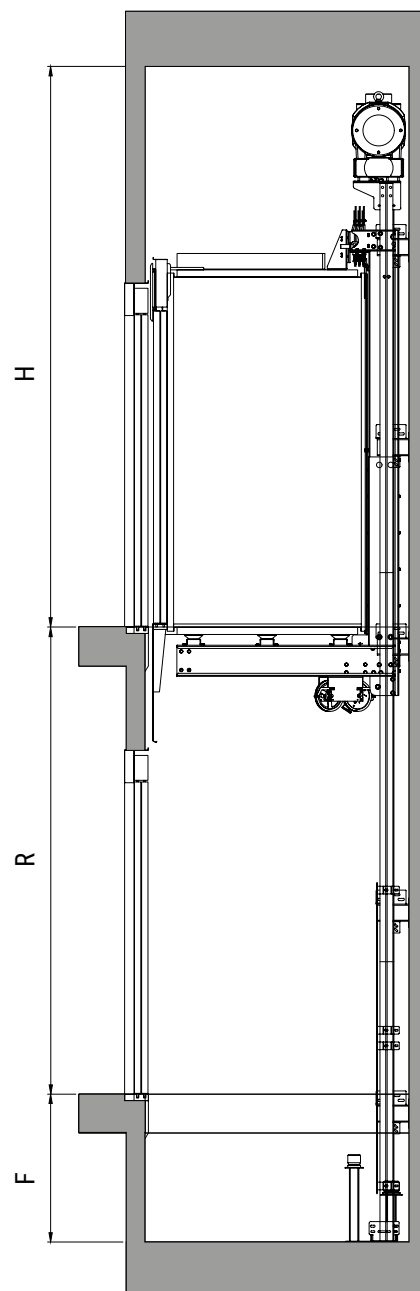







Plan view



Height



PL	Door opening
AC	Car width
FC	Car depth
AH	Pit width
FH	Pit depth
R	Travel
H	Headroom
F	Pit

REFERENCE	Characteristics				Doors			Car			Pit			
	Q Kg	P	V m/s	PT kW	T	PL mm	AP mm	AC mm	FC mm	A mm	AH mm	FH mm	F mm	H mm
														
iC31F	225	3	1	1,62	SB	700	2000	800	900	2220	1040	1340	1450	3600
iC41F	320	4	1	2,22	2T	700	2000	900	1000	2220	1230	1480	1005	3600
iC51F	320	4	1	2,22	SB	700	2000	900	1000	2220	1040	1440	1450	3600
iC51F	375	5	1	2,59	2T	700	2000	1000	1100	2220	1230	1570	1005	3600
iC61F	450	6	1	3,07	2T	800	2000	1000	1250	2220	1380	1760	1005	3600
PT Power Q Loading capacity P Max. n° of people V Speed				PL Doors opening AP Height of doors 2C 2 Panel side openings 2T 2 P. central openings SB Semi-automatic + bus T Type of door			AC Car width FC Car depth A Height			AH Pit width FH Pit depth F Pit H Headroom				

-Dimensions for standard cars and skinplate decoration with porcelain floor.

-If the dimensions of your lift and car do not correspond to that of the standard measurements consult our sales team.

-1 entrance car.

iC_2-180

Layouts and drawing



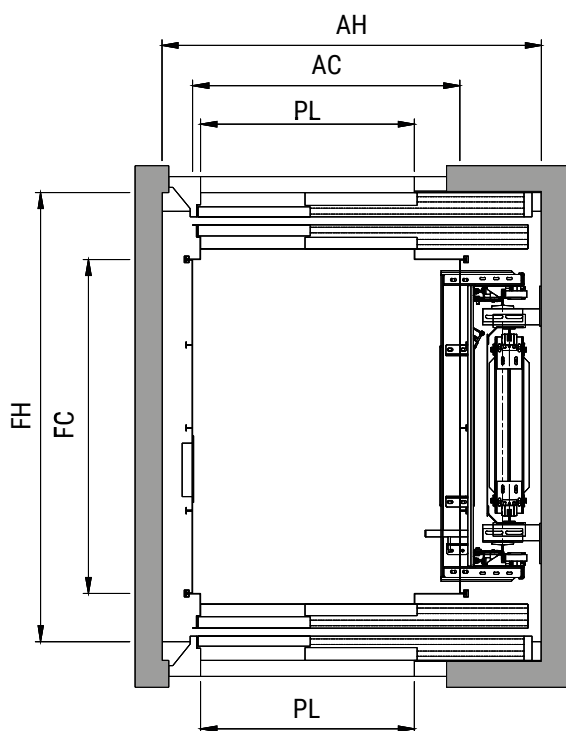



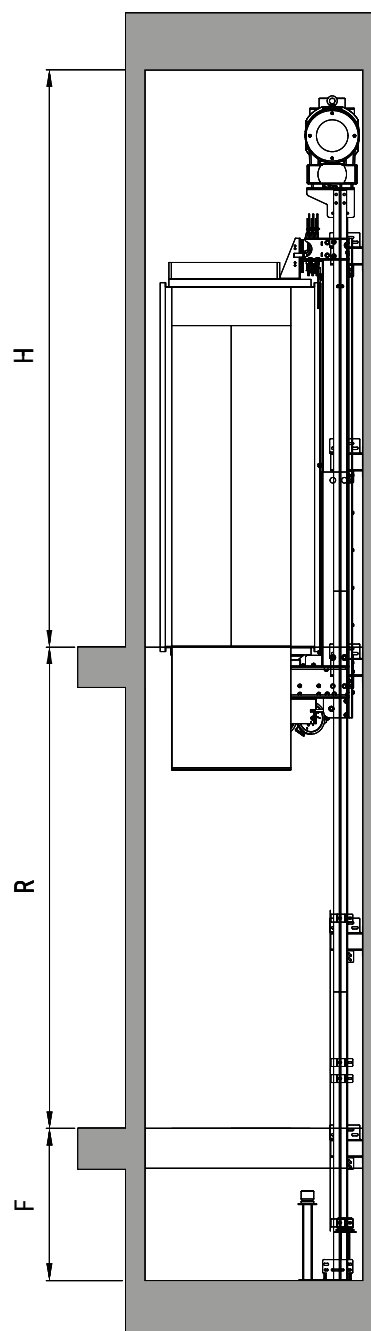







Plan view



Height



PL	Door opening
AC	Car width
FC	Car depth
AH	Pit width
FH	Pit depth
R	Travel
H	Headroom
F	Pit

REFERENCE	Characteristics				Doors			Car			Pit			
	Q Kg	P	V m/s	PT kW	T	PL mm	AP mm	AC mm	FC mm	A mm	AH mm	FH mm	F mm	H mm
														
iC32-180	225	3	1	1,62	2T	700	2000	800	900	2220	1270	1260	1450	3600
	225	3	1	1,62	SB	700	2000	800	900	2220	1240	1180	1450	3600
iC42-180	320	4	1	2,22	2T	700	2000	900	1000	2220	1330	1360	1180	3600
	320	4	1	2,22	SB	700	2000	900	1000	2220	1330	1290	1180	3600
iC52-180	375	5	1	2,59	2T	700	2000	1000	1100	2220	1430	1460	1005	3600
iC62-180	450	6	1	3,07	2T	800	2000	1000	1250	2220	1430	1610	1005	3600
iC72-180	525	7	1	3,45	2T	800	2000	1100	1250	2220	1570	1610	1005	3600
iC82-180	630	8	1	4,11	2T	900	2000	1100	1400	2220	1570	1760	1005	3600
iC92-180	675	9	1	4,37	2T	900	2000	1200	1400	2220	1670	1760	1005	3600
	PT Power Q Loading capacity P Max. n° of people V Speed				PL Doors opening AP Height of doors 2C 2 Panel side openings 2T 2 P. central openings SB Semi-automatic + bus T Type of door			AC Car width FC Car depth A Height			AH Pit width FH Pit depth F Pit H Headroom			

-Dimensions for standard cars and skinplate decoration with porcelain floor.
 -If the dimensions of your lift and car do not correspond to that of the standard measurements consult our sales team.
 -2 entrance car.

iC_2-90

Layouts and drawing



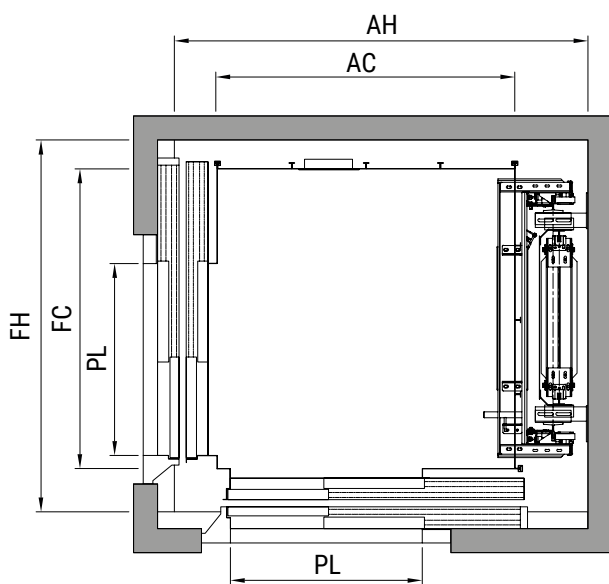



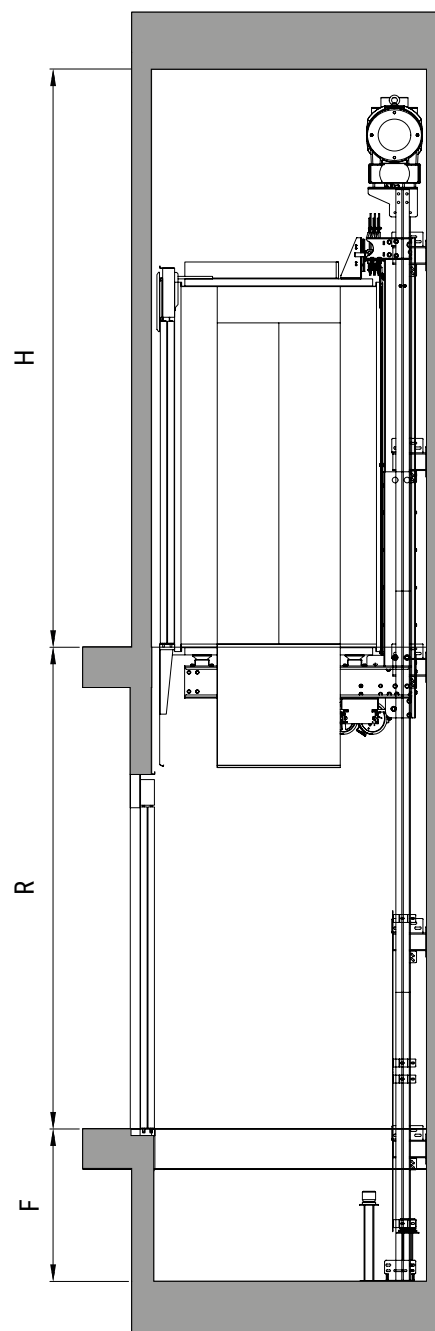







Plan view



Height



PL	Door opening
AC	Car width
FC	Car depth
AH	Pit width
FH	Pit depth
R	Travel
H	Headroom
F	Pit

REFERENCE	Characteristics				Doors			Car			Pit			
	Q Kg	P	V m/s	PT kW	T	PL mm	AP mm	AC mm	FC mm	A mm	AH mm	FH mm	F mm	H mm
														
iC32-90	225	3	1	1,62	2T	700	2000	800	900	2220	1280	1260	1450	3600
	225	3	1	1,62	SB	700	2000	800	900	2220	1240	1180	1450	3600
iC42-90	320	4	1	2,22	2T	700	2000	900	1000	2220	1380	1320	1005	3600
	320	4	1	2,22	SB	700	2000	900	1000	2220	1340	1280	1005	3600
iC52-90	375	5	1	2,59	2T	700	2000	1000	1100	2220	1480	1420	1005	3600
iC62-90	450	6	1	3,07	2T	800	2000	1000	1250	2220	1480	1570	1005	3600
iC72-90	525	7	1	3,45	2T	800	2000	1100	1250	2220	1620	1570	1005	3600
iC82-90	630	8	1	4,11	2T	800	2000	1250	1250	2220	1770	1570	1005	3600
	PT Power Q Loading capacity P Max. nº of people V Speed				PL Doors opening AP Height of doors 2C 2 Panel side openings 2T 2 P. central openings SB Semi-automatic + bus T Type of door			AC Car width FC Car depth A Height			AH Pit width FH Pit depth F Pit H Headroom			

-Dimensions for standard cars and skinplate decoration with porcelain floor.

-If the dimensions of your lift and car do not correspond to that of the standard measurements consult our sales team.

-2 entrance car.