

Minicargas MH Simple

Planos y medidas

Planta

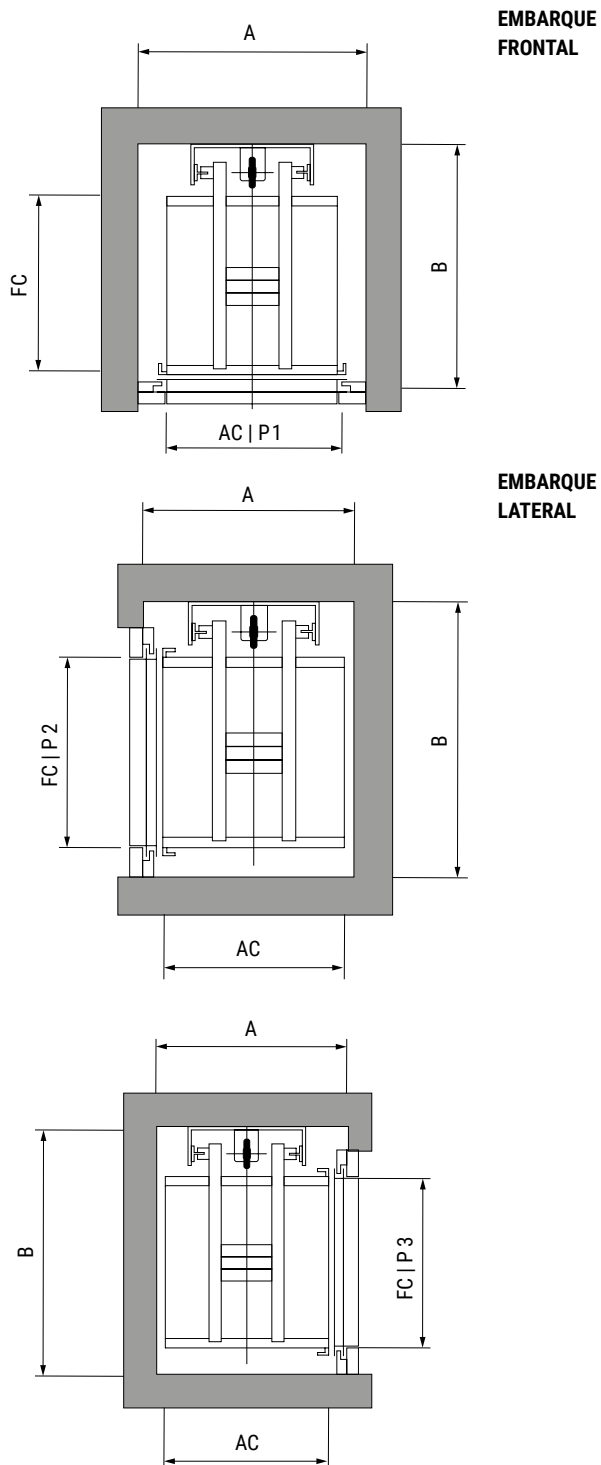



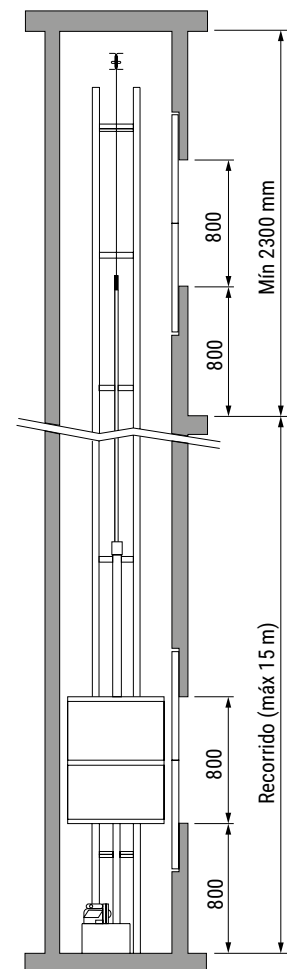









Alzado



AC	Ancho de cabina
FC	Fondo de cabina
P1	Puerta 1
P2	Puerta 2
P3	Puerta 3
A	Ancho de hueco
B	Fondo de hueco

Minicargas MH Simple

REFERENCIA	Características				Puertas			Cabina		Sin estructura		Con estructura	
	Q Kg	T kW	M kW	V m/s	P1 mm	P2 mm	P3 mm	AC mm	FC mm	A mm	B mm	A mm	B mm
													
EMBARQUE FRONTAL	50	0,37	0,55	0,40	500	-	-	500	500	660	705	785	785
	100	1,10	1,10	0,40	500	-	-	500	500	660	705	785	785
	50	0,37	0,55	0,40	600	-	-	600	600	760	805	885	885
	100	1,10	1,10	0,40	600	-	-	600	600	760	805	885	885
	50	0,37	0,55	0,40	650	-	-	650	650	810	855	935	935
	100	1,10	1,10	0,40	650	-	-	650	650	810	855	935	935
	50	0,37	0,55	0,40	700	-	-	700	700	860	905	985	985
	100	1,10	1,10	0,40	700	-	-	700	700	860	905	985	985
EMBARQUE LATERAL	50	0,37	0,55	0,40	-	500	500	500	500	585	730	690	835
	100	1,10	1,10	0,40	-	500	500	500	500	585	730	690	835
	50	0,37	0,55	0,40	-	600	600	600	600	685	830	790	935
	100	1,10	1,10	0,40	-	600	600	600	600	685	830	790	935
	50	0,37	0,55	0,40	-	650	650	650	650	735	880	840	985
	100	1,10	1,10	0,40	-	650	650	650	650	735	880	840	985
	50	0,37	0,55	0,40	-	700	700	700	700	785	930	890	1035
	100	1,10	1,10	0,40	-	700	700	700	700	785	930	890	1035
	Q Capacidad de carga M Potencia monofásico T Potencia trifásico V Velocidad				P1 Puerta 1 P2 Puerta 2 P3 Puerta 3			AC Ancho de cabina FC Fondo de cabina		A Ancho de hueco B Fondo de hueco		A Ancho de hueco B Fondo de hueco	

- En el modelo de embarque lateral se da la posibilidad de elegir la ubicación de la puerta entre P2 o entre P3, nunca ambos en este modelo.
- Dimensiones para cabinas estándar.
- Si las medidas de hueco de su minicargas no corresponden a la de las tablas consulte a nuestro equipo comercial.
- Modelo de 1 embarque.

Minicargas MH Combinado

Planos y medidas

Planta

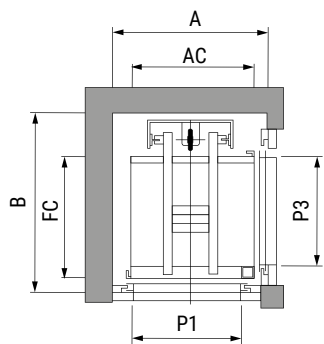

EMBARQUE
DOBLE A 90

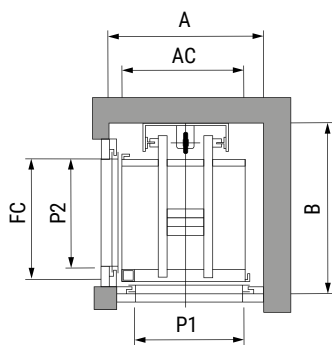

EMBARQUE
DOBLE A 180

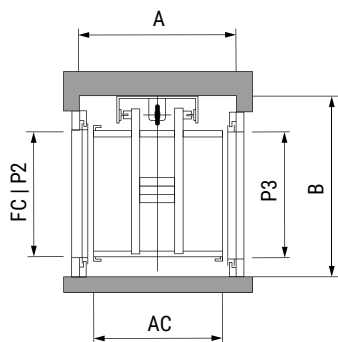

EMBARQUE
TRIPLE

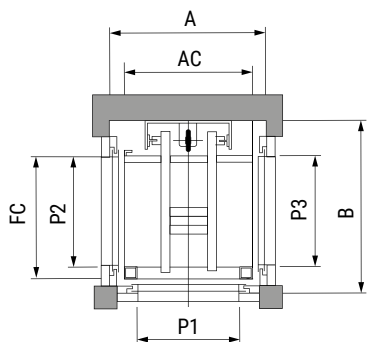



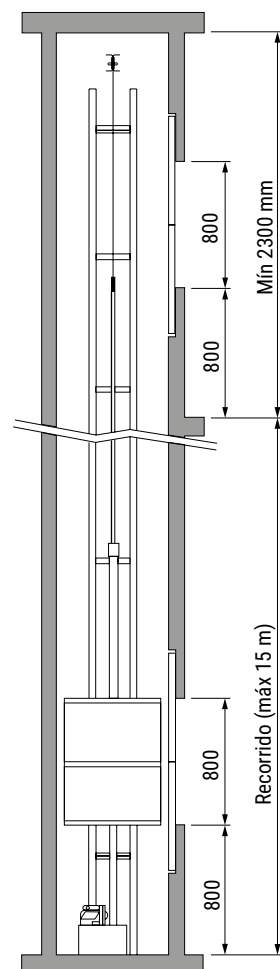









Alzado



AC	Ancho de cabina
FC	Fondo de cabina
P1	Puerta 1
P2	Puerta 2
P3	Puerta 3
A	Ancho de hueco
B	Fondo de hueco

Minicargas MH Combinado

REFERENCIA	Características				Puertas			Cabina		Sin estructura		Con estructura	
	Q Kg	T kW	M kW	V m/s	P1 mm	P2 mm	P3 mm	AC mm	FC mm	A mm	B mm	A mm	B mm
													
EMBARQUE DOBLE A 90	50	0,37	0,55	0,40	450	450	450	500	500	635	705	735	785
	100	1,10	1,10	0,40	450	450	450	500	500	635	705	735	785
	50	0,37	0,55	0,40	550	550	550	600	600	735	805	835	885
	100	1,10	1,10	0,40	550	550	550	600	600	735	805	835	885
	50	0,37	0,55	0,40	600	600	600	650	650	785	855	885	935
	100	1,10	1,10	0,40	600	600	600	650	650	785	855	885	935
	50	0,37	0,55	0,40	650	650	650	700	700	835	905	935	985
	100	1,10	1,10	0,40	650	650	650	700	700	835	905	935	985
EMBARQUE DOBLE A 180	50	0,37	0,55	0,40	-	500	500	500	500	610	730	690	835
	100	1,10	1,10	0,40	-	500	500	500	500	610	730	690	835
	50	0,37	0,55	0,40	-	600	600	600	600	710	830	790	935
	100	1,10	1,10	0,40	-	600	600	600	600	710	830	790	935
	50	0,37	0,55	0,40	-	650	650	650	650	760	880	840	985
	100	1,10	1,10	0,40	-	650	650	650	650	760	880	840	985
	50	0,37	0,55	0,40	-	700	700	700	700	810	930	890	1035
	100	1,10	1,10	0,40	-	700	700	700	700	810	930	890	1035
EMBARQUE TRIPLE	50	0,37	0,55	0,40	400	450	450	500	500	610	705	690	785
	100	1,10	1,10	0,40	400	450	450	500	500	610	705	690	785
	50	0,37	0,55	0,40	500	550	550	600	600	710	805	790	885
	100	1,10	1,10	0,40	500	550	550	600	600	710	805	790	885
	50	0,37	0,55	0,40	550	600	600	650	650	760	855	840	935
	100	1,10	1,10	0,40	550	600	600	650	650	760	855	840	935
	50	0,37	0,55	0,40	600	650	650	700	700	810	905	890	985
	100	1,10	1,10	0,40	600	650	650	700	700	810	905	890	985

-Dimensiones para cabinas estándar.

-Si las medidas de hueco de su minicargas no corresponden a la de las tablas consulte a nuestro equipo comercial.

-Modelo de 2 o 3 embarques.