

# iCompact

## Lifts

This model has the same technology as the Ecomagnet range but is designed to optimize the lift shaft to offer more space in the car. It is designed to be installed in apartment buildings or neighbouring communities.

Like the Ecomagnet models, they do not need a machine room to work.

This lift is designed for communities, work centres, public buildings and homes.

 225 - 675 kg

 3 - 9 persons

 Maximum travel 45 m

 At 180°, 90° and 0°

 Electric

 Speed 1 m/s

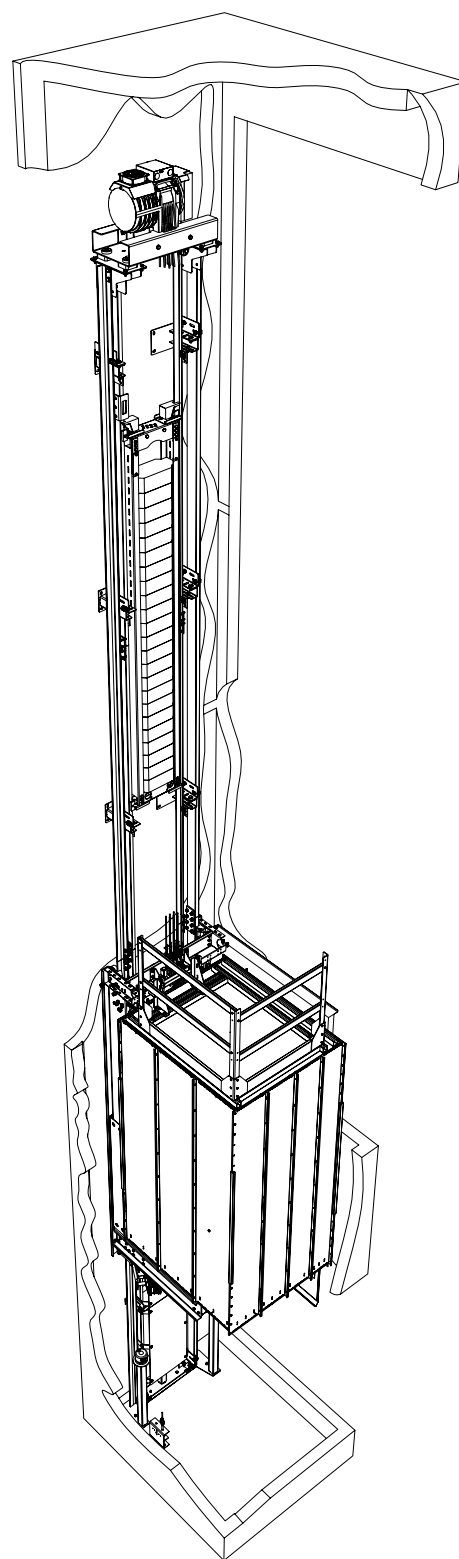

iC\_1L

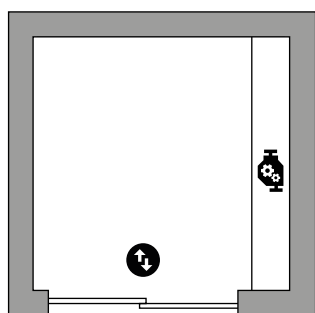

iC\_1F

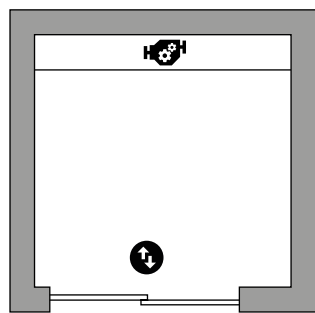

iC\_2-180

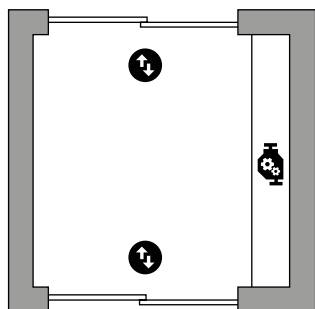

iC\_2-90

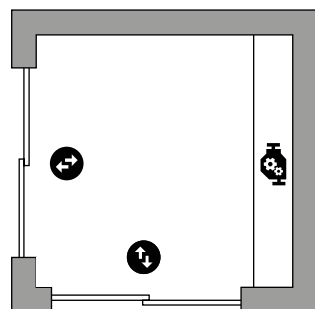



### Basic configuration

- Car doors in epoxy.
- Car door in stainless steel.
- Skinplate car. Z1 car
- Selective simplex on descent.
- Manual rescue control.
- Stainless steel car keypad with round buttons and with BRAILLE.
- Landing keypad in the steel door frame stainless with oval or round button and with BRAILLE.
- Digital position, directional arrows and load weighing in the car.
- Intercom.
- Acoustic indicator of doors opening.
- Voice synthesizer.
- Optical curtain. (Safety edge)

# iC\_1L

## Layouts and drawing



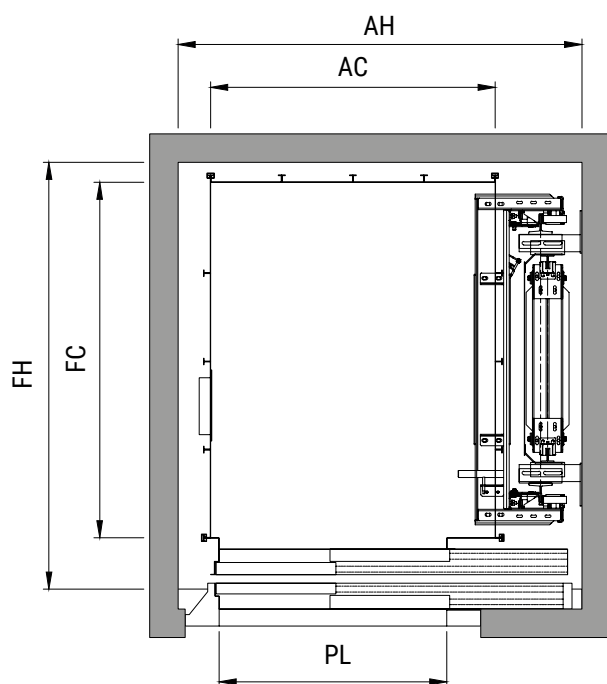



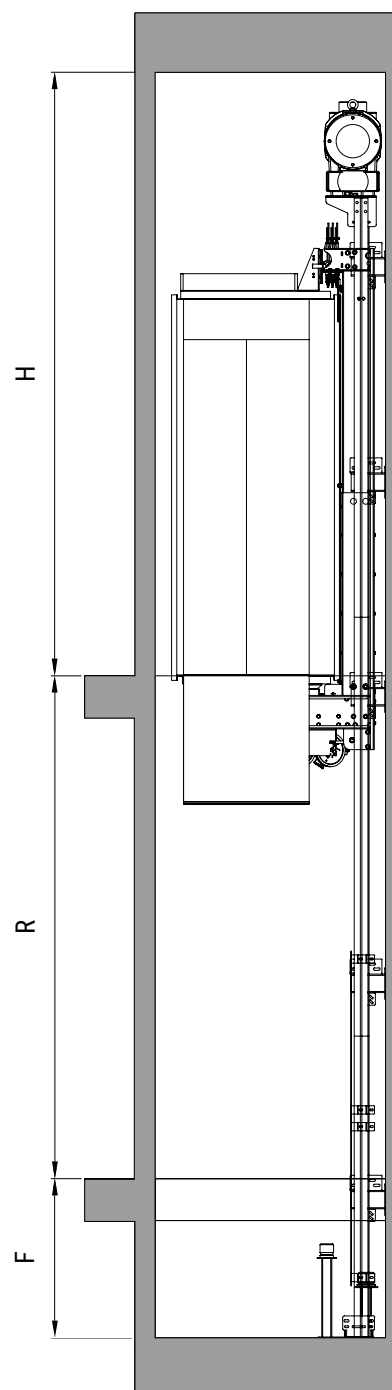







Plan view



Height



PL	Door opening
AC	Car width
FC	Car depth
AH	Pit width
FH	Pit depth
R	Travel
H	Headroom
F	Pit

REFERENCE	Characteristics				Doors			Car			Pit			
	Q Kg	P	V m/s	PT kW	T	PL mm	AP mm	AC mm	FC mm	A mm	AH mm	FH mm	F mm	H mm
														
<b>iC31L</b>	225	3	1	1,62	2T	650	2000	800	900	2220	1230	1150	1450	3600
	225	3	1	1,62	SB	700	2000	800	900	2220	1240	1100	1450	3600
<b>iC41L</b>	320	4	1	2,22	2T	700	2000	900	1000	2220	1330	1260	1180	3600
	320	4	1	2,22	SB	700	2000	900	1000	2220	1330	1210	1180	3600
<b>iC51L</b>	375	5	1	2,59	2T	700	2000	1000	1100	2220	1430	1350	1005	3600
<b>iC61L</b>	450	6	1	3,07	2T	800	2000	1000	1250	2220	1430	1500	1005	3600
<b>iC71L</b>	525	7	1	3,45	2T	800	2000	1100	1250	2220	1570	1500	1005	3600
<b>iC81L</b>	630	8	1	4,11	2T	900	2000	1100	1400	2220	1570	1650	1005	3600
<b>iC91L</b>	675	9	1	4,37	2T	900	2000	1200	1400	2220	1670	1650	1005	3600
	<b>PT</b> Power <b>Q</b> Loading capacity <b>P</b> Max. n° of people <b>V</b> Speed				<b>PL</b> Doors opening <b>AP</b> Height of doors <b>2C</b> 2 Panel side openings <b>2T</b> 2 P. central openings <b>SB</b> Semi-automatic + bus <b>T</b> Type of door			<b>AC</b> Car width <b>FC</b> Car depth <b>A</b> Height			<b>AH</b> Pit width <b>FH</b> Pit depth <b>F</b> Pit <b>H</b> Headroom			

- Dimensions for standard cars and skinplate decoration with porcelain floor.

- If the dimensions of your lift and car do not correspond to that of the standard measurements consult our sales team.

- 1 entrance car.

# iC\_1F

## Layouts and drawing



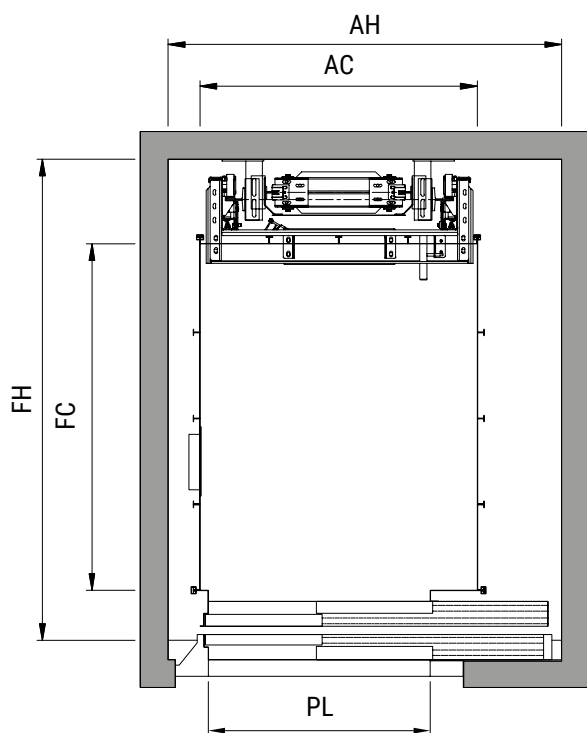



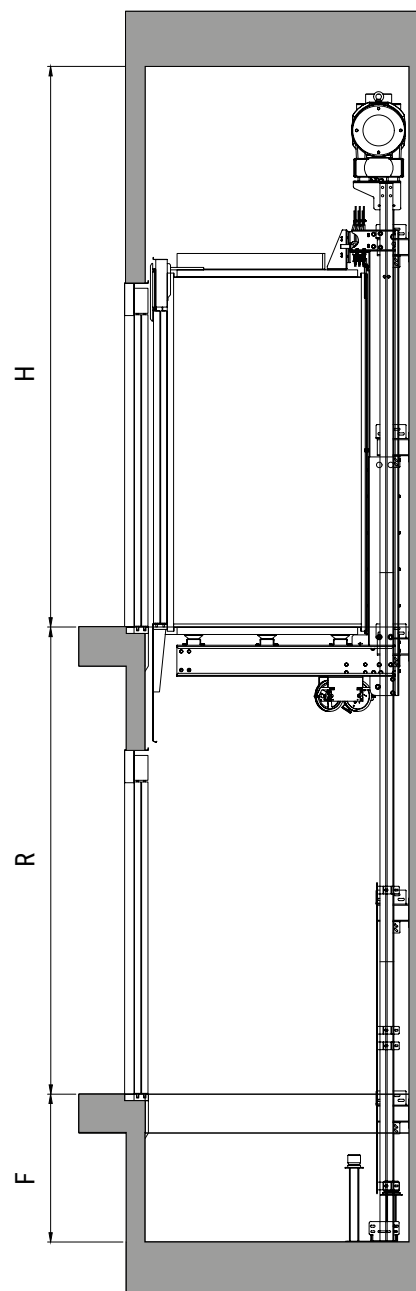







Plan view



Height



PL	Door opening
AC	Car width
FC	Car depth
AH	Pit width
FH	Pit depth
R	Travel
H	Headroom
F	Pit

REFERENCE	Characteristics				Doors			Car			Pit			
	Q Kg	P	V m/s	PT kW	T	PL mm	AP mm	AC mm	FC mm	A mm	AH mm	FH mm	F mm	H mm
														
<b>iC31F</b>	225	3	1	1,62	SB	700	2000	800	900	2220	1040	1340	1450	3600
<b>iC41F</b>	320	4	1	2,22	2T	700	2000	900	1000	2220	1230	1480	1005	3600
<b>iC51F</b>	320	4	1	2,22	SB	700	2000	900	1000	2220	1040	1440	1450	3600
<b>iC51F</b>	375	5	1	2,59	2T	700	2000	1000	1100	2220	1230	1570	1005	3600
<b>iC61F</b>	450	6	1	3,07	2T	800	2000	1000	1250	2220	1380	1760	1005	3600
<b>PT</b> Power <b>Q</b> Loading capacity <b>P</b> Max. n° of people <b>V</b> Speed				<b>PL</b> Doors opening <b>AP</b> Height of doors <b>2C</b> 2 Panel side openings <b>2T</b> 2 P. central openings <b>SB</b> Semi-automatic + bus <b>T</b> Type of door			<b>AC</b> Car width <b>FC</b> Car depth <b>A</b> Height			<b>AH</b> Pit width <b>FH</b> Pit depth <b>F</b> Pit <b>H</b> Headroom				

-Dimensions for standard cars and skinplate decoration with porcelain floor.

-If the dimensions of your lift and car do not correspond to that of the standard measurements consult our sales team.

-1 entrance car.

# iC\_2-180

## Layouts and drawing



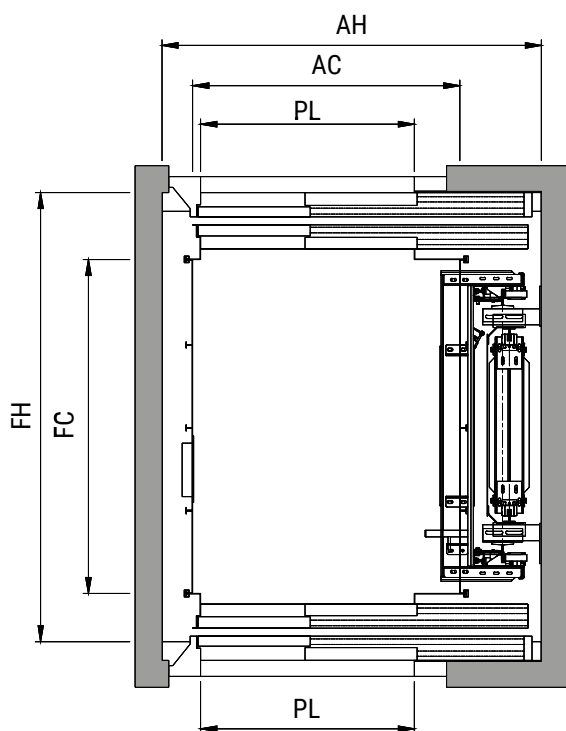



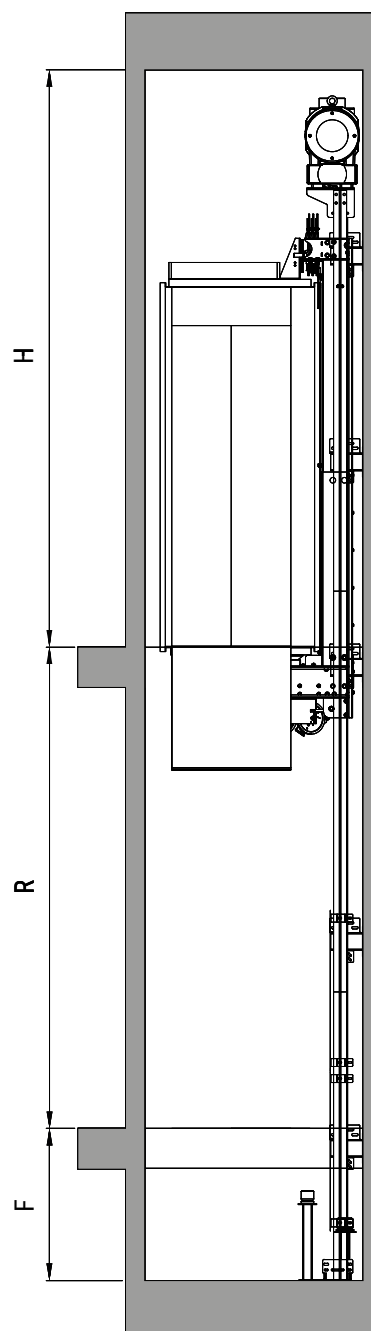







Plan view



Height



PL	Door opening
AC	Car width
FC	Car depth
AH	Pit width
FH	Pit depth
R	Travel
H	Headroom
F	Pit

REFERENCE	Characteristics				Doors			Car			Pit			
	<b>Q</b> Kg	<b>P</b>	<b>V</b> m/s	<b>PT</b> kW	<b>T</b>	<b>PL</b> mm	<b>AP</b> mm	<b>AC</b> mm	<b>FC</b> mm	<b>A</b> mm	<b>AH</b> mm	<b>FH</b> mm	<b>F</b> mm	<b>H</b> mm
														
<b>iC32-180</b>	225	3	1	1,62	2T	700	2000	800	900	2220	1270	1260	1450	3600
	225	3	1	<b>1,62</b>	SB	<b>700</b>	<b>2000</b>	800	900	2220	1240	<b>1180</b>	<b>1450</b>	<b>3600</b>
<b>iC42-180</b>	320	4	1	2,22	2T	700	2000	900	1000	2220	1330	1360	1180	3600
	320	4	1	<b>2,22</b>	SB	<b>700</b>	<b>2000</b>	900	1000	2220	1330	<b>1290</b>	<b>1180</b>	<b>3600</b>
<b>iC52-180</b>	375	5	1	2,59	2T	700	2000	1000	1100	2220	1430	1460	1005	3600
<b>iC62-180</b>	450	6	1	3,07	2T	800	2000	1000	1250	2220	1430	1610	1005	3600
<b>iC72-180</b>	525	7	1	3,45	2T	800	2000	1100	1250	2220	1570	1610	1005	3600
<b>iC82-180</b>	630	8	1	4,11	2T	900	2000	1100	1400	2220	1570	1760	1005	3600
<b>iC92-180</b>	675	9	1	4,37	2T	900	2000	1200	1400	2220	1670	1760	1005	3600
	<b>PT</b> Power <b>Q</b> Loading capacity <b>P</b> Max. n° of people <b>V</b> Speed				<b>PL</b> Doors opening <b>AP</b> Height of doors <b>2C</b> 2 Panel side openings <b>2T</b> 2 P. central openings <b>SB</b> Semi-automatic + bus <b>T</b> Type of door			<b>AC</b> Car width <b>FC</b> Car depth <b>A</b> Height			<b>AH</b> Pit width <b>FH</b> Pit depth <b>F</b> Pit <b>H</b> Headroom			

-Dimensions for standard cars and skinplate decoration with porcelain floor.  
 -If the dimensions of your lift and car do not correspond to that of the standard measurements consult our sales team.  
 -2 entrance car.



# iC\_2-90

## Layouts and drawing



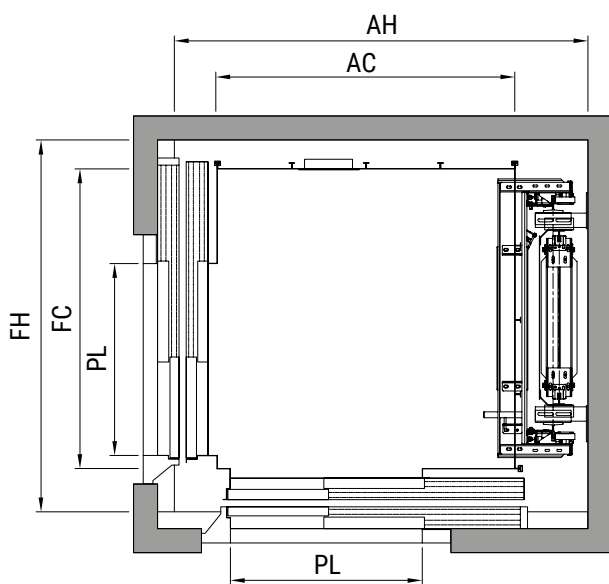



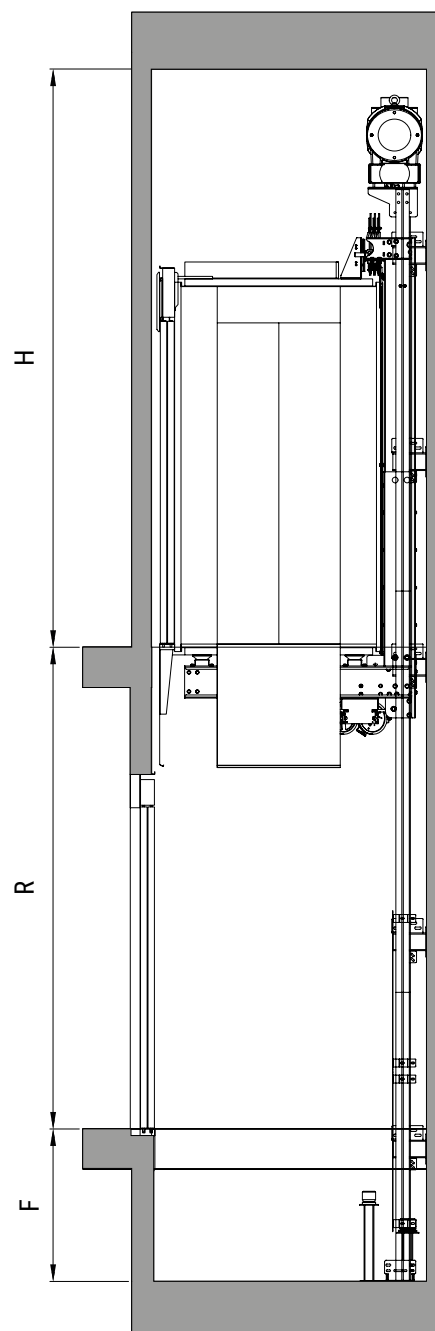







Plan view



Height



PL	Door opening
AC	Car width
FC	Car depth
AH	Pit width
FH	Pit depth
R	Travel
H	Headroom
F	Pit

REFERENCE	Characteristics				Doors			Car			Pit			
	Q Kg	P	V m/s	PT kW	T	PL mm	AP mm	AC mm	FC mm	A mm	AH mm	FH mm	F mm	H mm
														
<b>iC32-90</b>	225	3	1	1,62	2T	700	2000	800	900	2220	1280	1260	1450	3600
	225	3	1	1,62	SB	700	2000	800	900	2220	1240	1180	1450	3600
<b>iC42-90</b>	320	4	1	2,22	2T	700	2000	900	1000	2220	1380	1320	1005	3600
	320	4	1	2,22	SB	700	2000	900	1000	2220	1340	1280	1005	3600
<b>iC52-90</b>	375	5	1	2,59	2T	700	2000	1000	1100	2220	1480	1420	1005	3600
<b>iC62-90</b>	450	6	1	3,07	2T	800	2000	1000	1250	2220	1480	1570	1005	3600
<b>iC72-90</b>	525	7	1	3,45	2T	800	2000	1100	1250	2220	1620	1570	1005	3600
<b>iC82-90</b>	630	8	1	4,11	2T	800	2000	1250	1250	2220	1770	1570	1005	3600
	<b>PT</b> Power <b>Q</b> Loading capacity <b>P</b> Max. nº of people <b>V</b> Speed				<b>PL</b> Doors opening <b>AP</b> Height of doors <b>2C</b> 2 Panel side openings <b>2T</b> 2 P. central openings <b>SB</b> Semi-automatic + bus <b>T</b> Type of door			<b>AC</b> Car width <b>FC</b> Car depth <b>A</b> Height			<b>AH</b> Pit width <b>FH</b> Pit depth <b>F</b> Pit <b>H</b> Headroom			

-Dimensions for standard cars and skinplate decoration with porcelain floor.  
 -If the dimensions of your lift and car do not correspond to that of the standard measurements consult our sales team.  
 -2 entrance car.